

Vazão: 70 lpm
 Pressão: 350 bar

Esquema Hidráulico

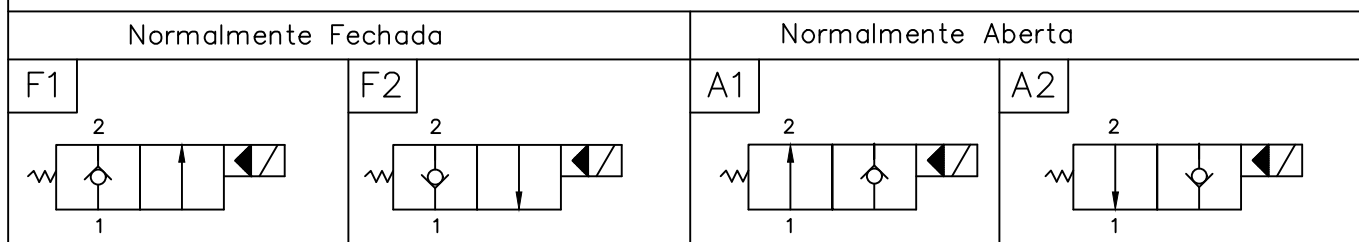

Bobinas

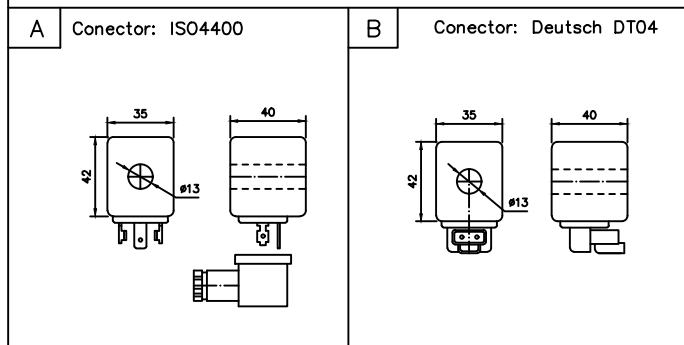

Cavidade SAE 10/2

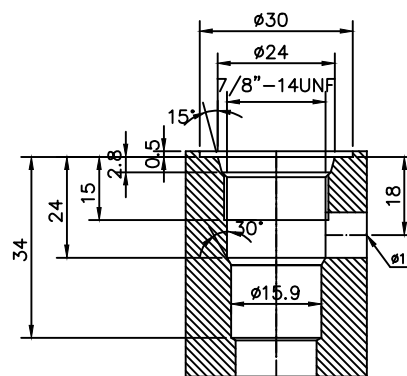

Características Bobinas:
 Potência Nominal: 21W
 Isolamento: ClasseH(180°)
 Proteção: IP65

Volts	Corrente Nominal
12 VCC	1,75A
24 VCC	0,87A
220 VCA	0,09A
110 VCA	0,19A

Como Solicitar

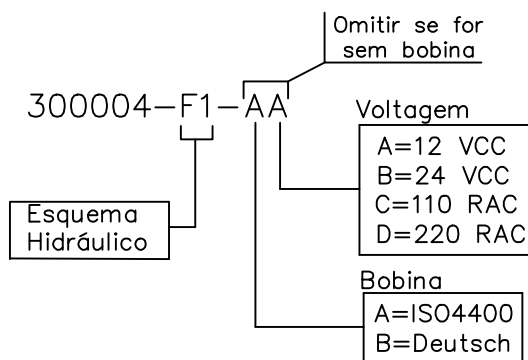

Control Star

Denominação:
 Válvula Solenóide SAE10/2

Código:
 300004-